

SIRUBA®

銀箭牌工業用縫紉機

INDUSTRIAL SEWING MACHINE

L818F-DM1







零件圖 PARTS LIST

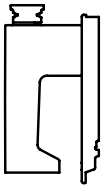

CE

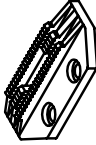
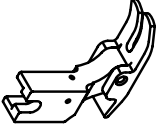

高林股份有限公司
KAULIN MFG. CO., LTD.

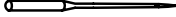
								
MODEL	SUB-CLASS	NEEDLE PLATE	FEED DOG	PRESSER FOOT	HOOK ASM	BOBBIN CASE ASM	BOBBIN	NEEDLE
機 型	規 格	針 板	送 具	押 具	梭 頭	梭 殼	梭 子	針 號
L818F-DM1	半無油式 中厚布料	E704	D701	P701	G111	G201	G301	DB*1#14
L818F-DM1A		E704D	D702	P701	G111	G201	G301	DB*1#14
L818F-DM3	無油式 中厚布料	E701	D701	P701	G141 G142	G206	G303	DB*1#14

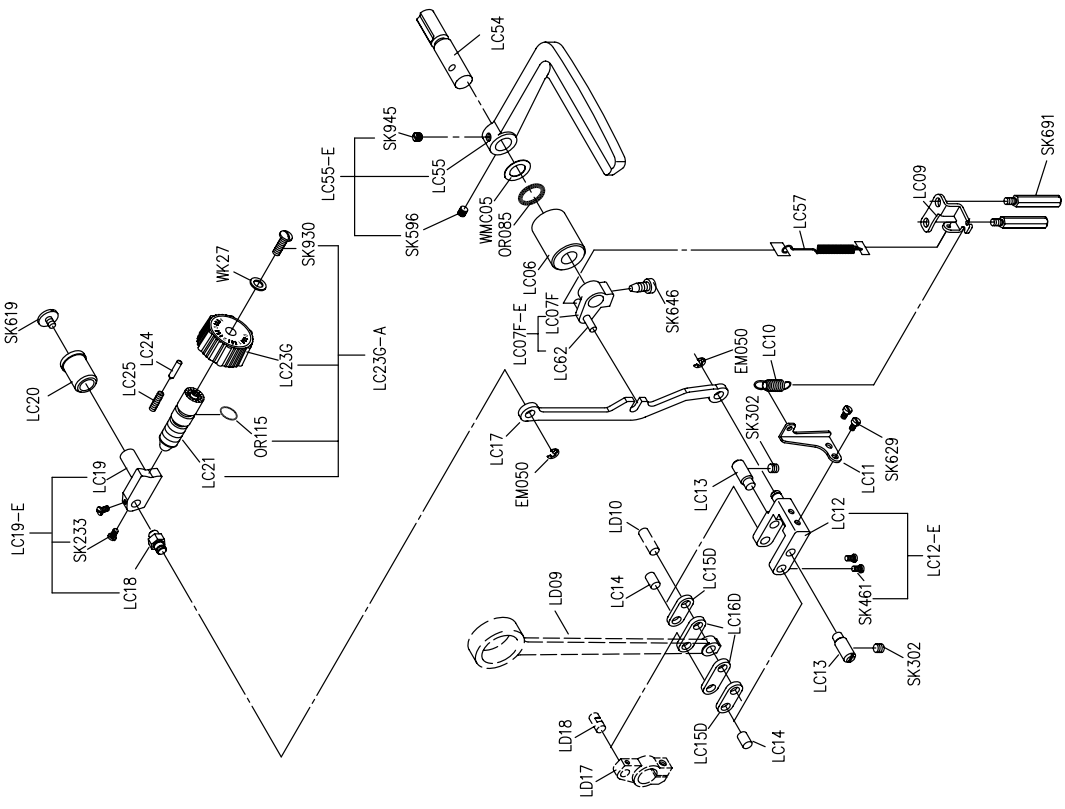
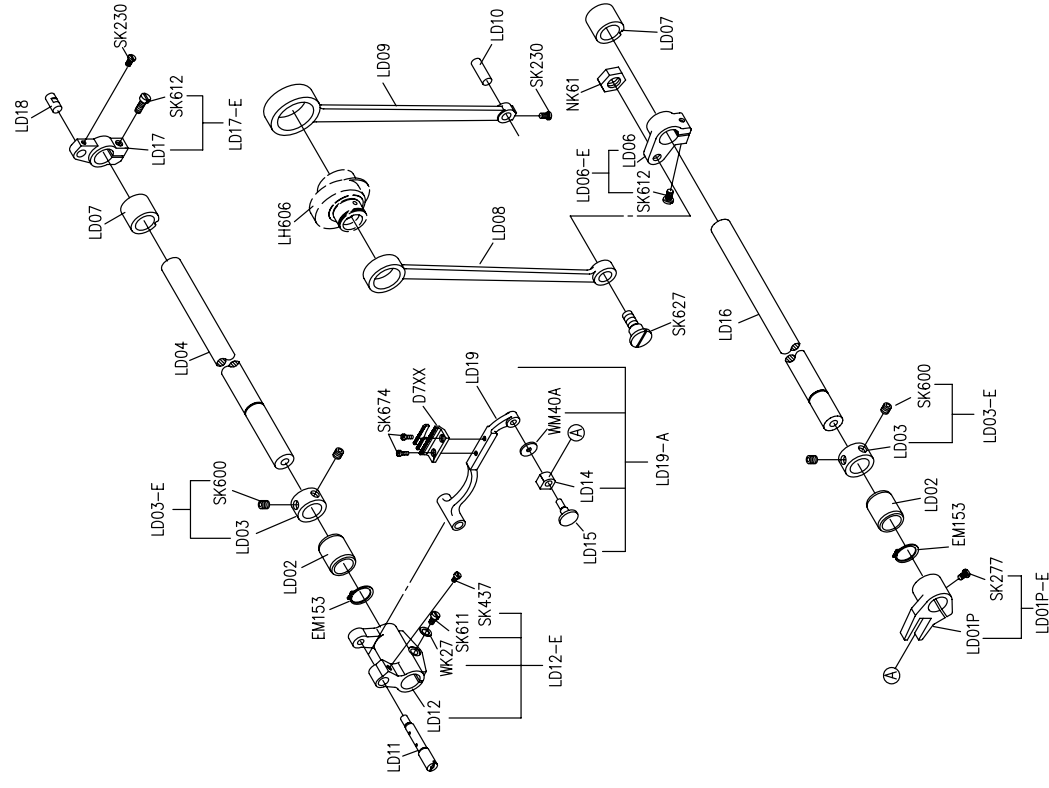

PARTS LIST FOR LC GROUP

PARTS LIST FOR LD GROUP

PARTS LIST FOR LE GROUP

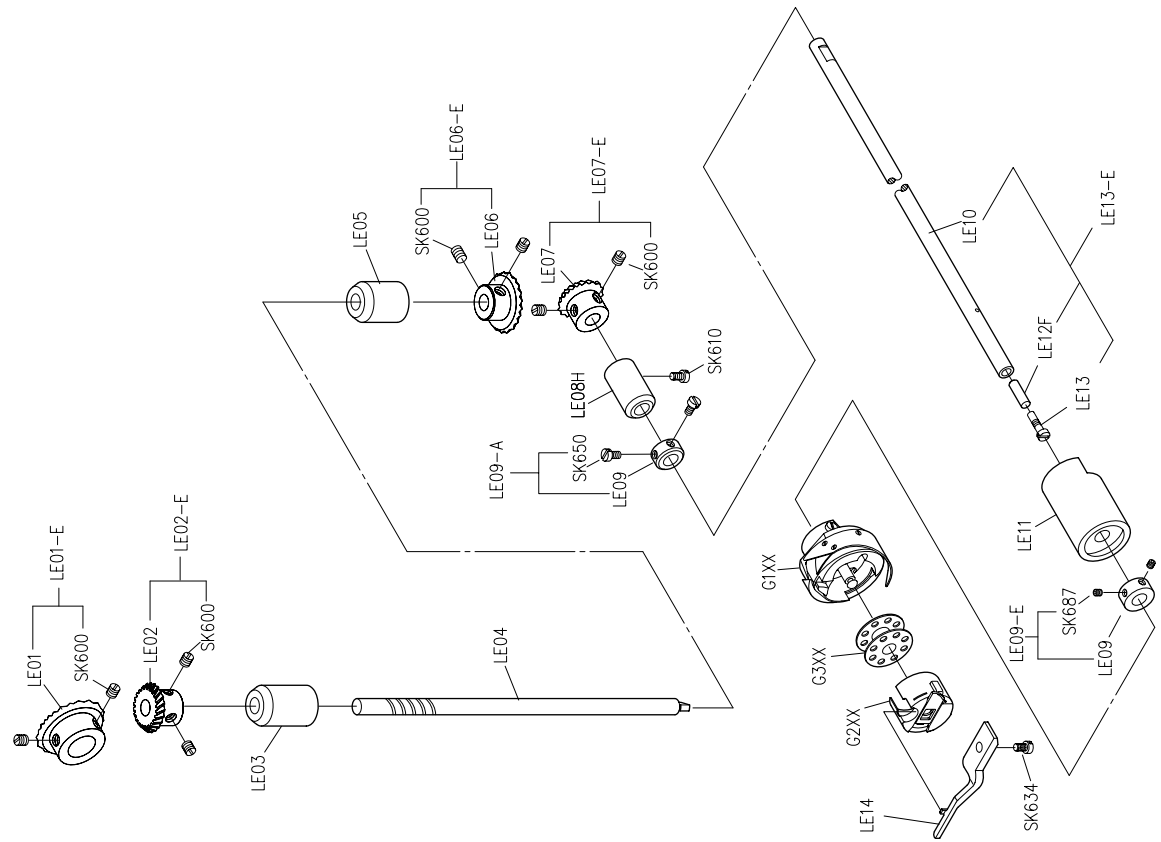

PARTS LIST FOR LG GROUP

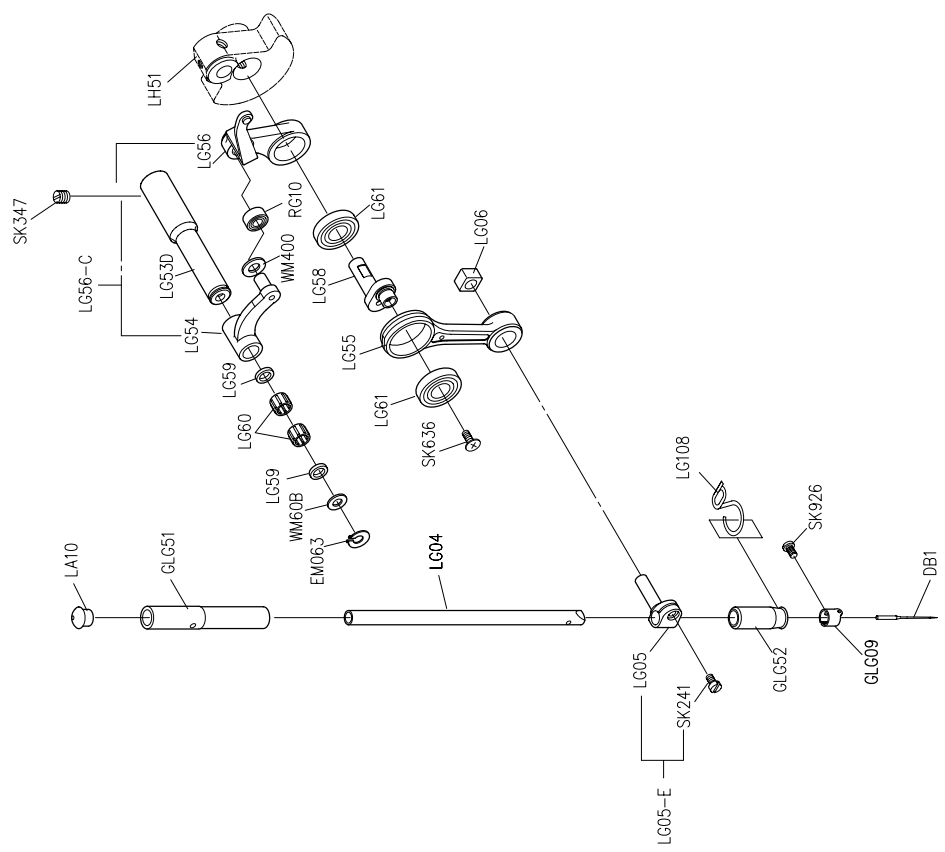

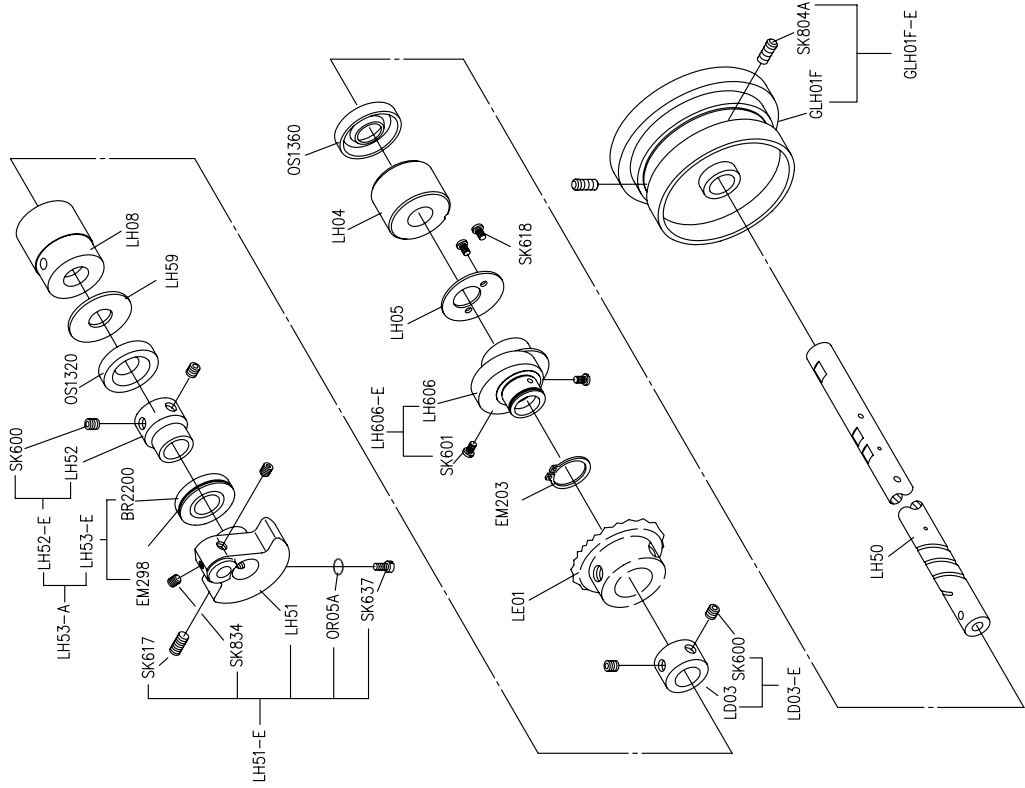
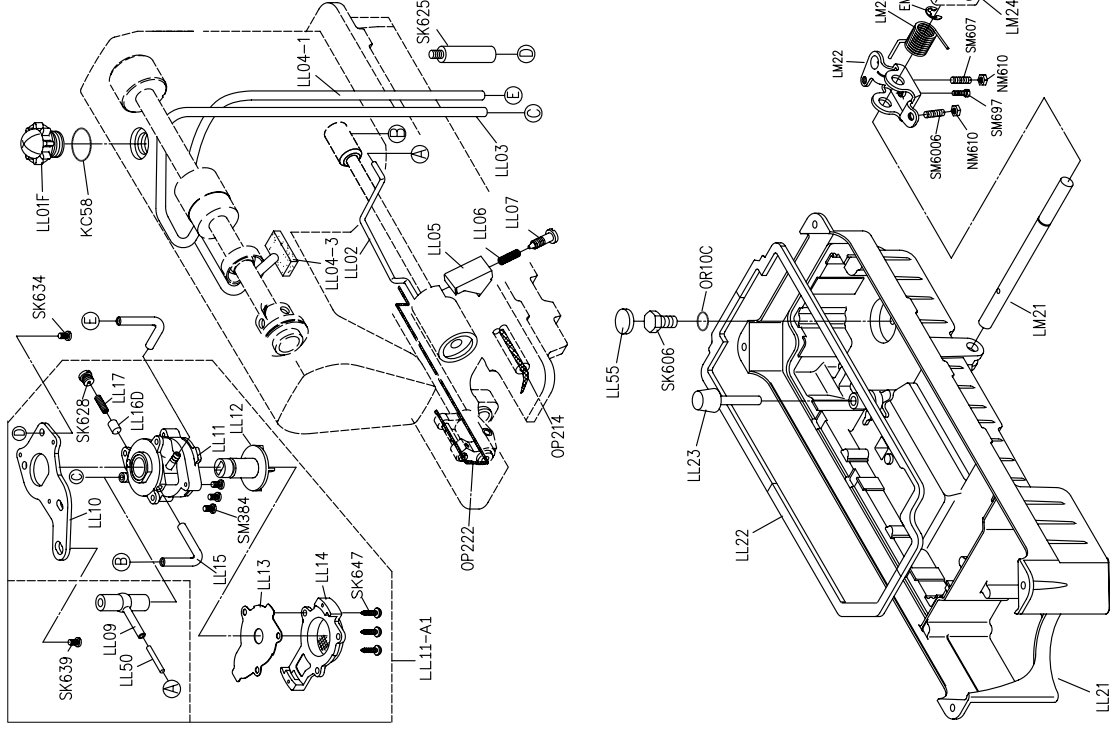

PARTS LIST FOR LH GROUP

PARTS LIST FOR LL GROUP

PARTS LIST FOR LM GROUP

PARTS LIST FOR LY GROUP

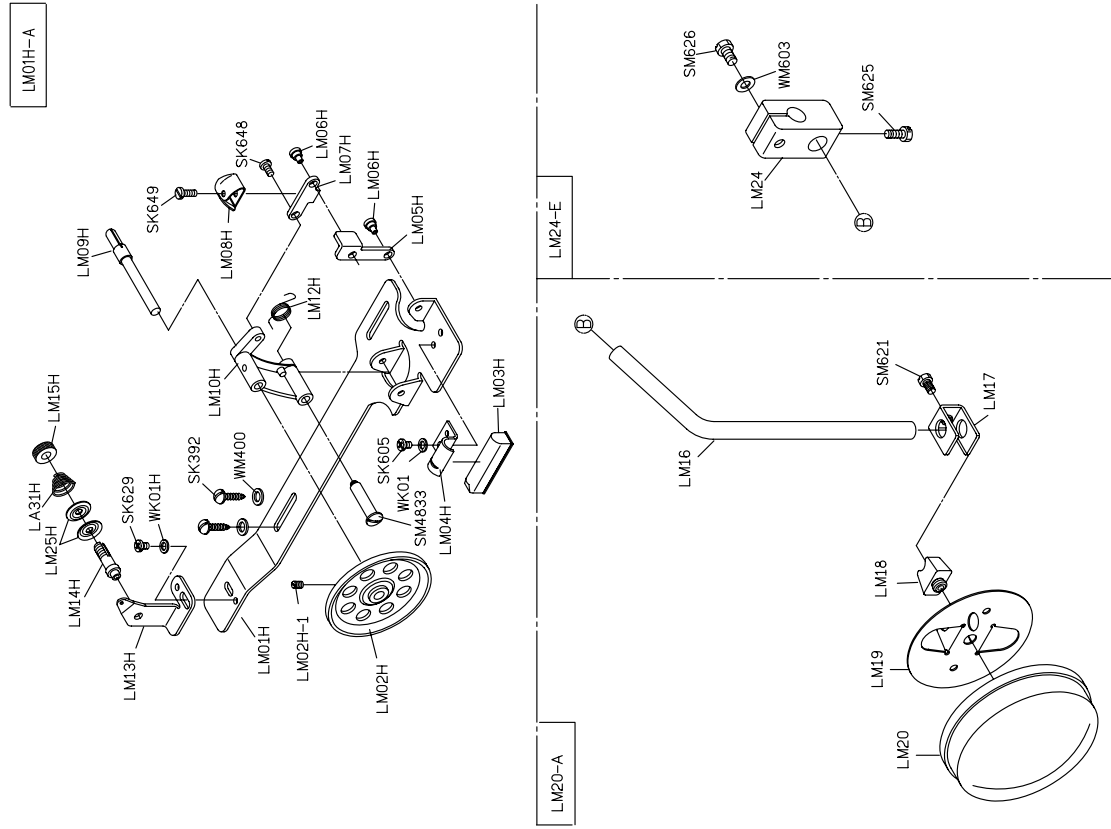

LY01	LY02	YM04*2	LY05*2	YM102*2
LY08F	LY18	LY26	LY21-A	YM103*2
				G3XX*2
†*2	GMY01	MY11	KZ03*1	
LY33	LY34	LY35	LY23H	

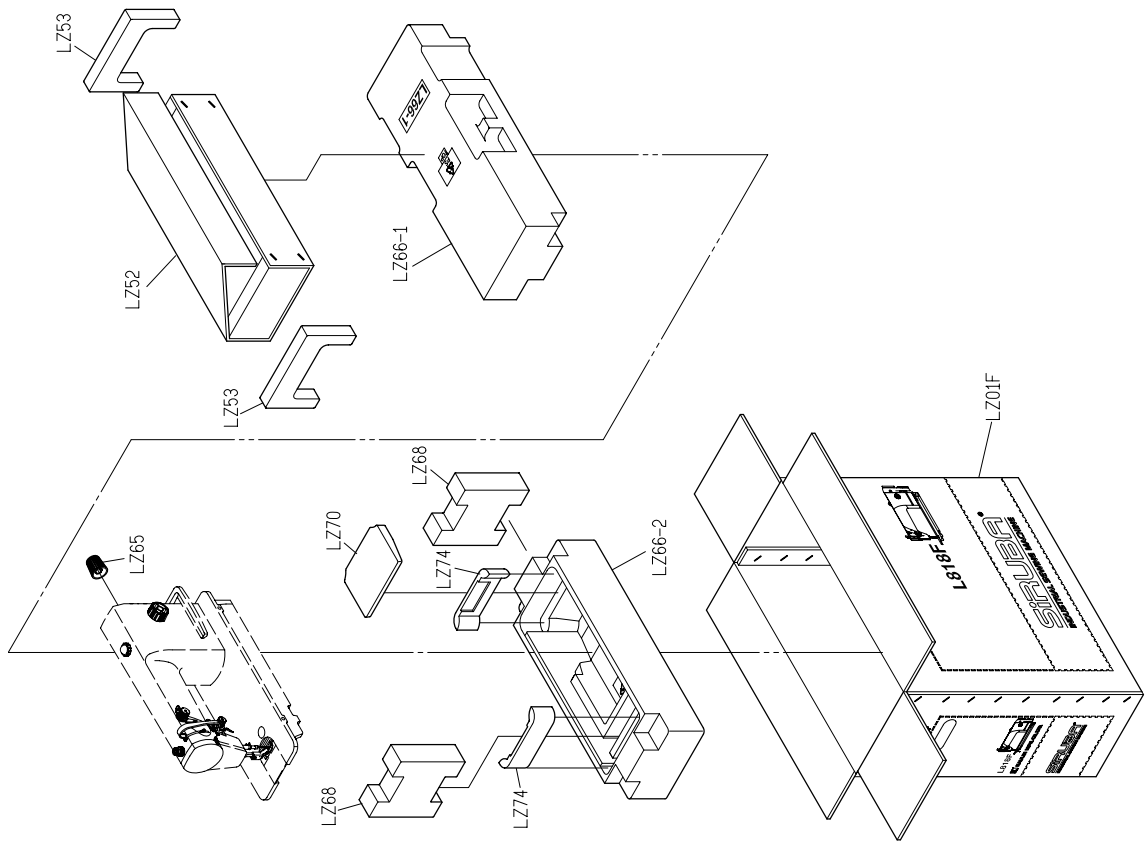



L818F-DM1

高林股份有限公司 KAULIN MFG. CO., LTD.